

## Ograde

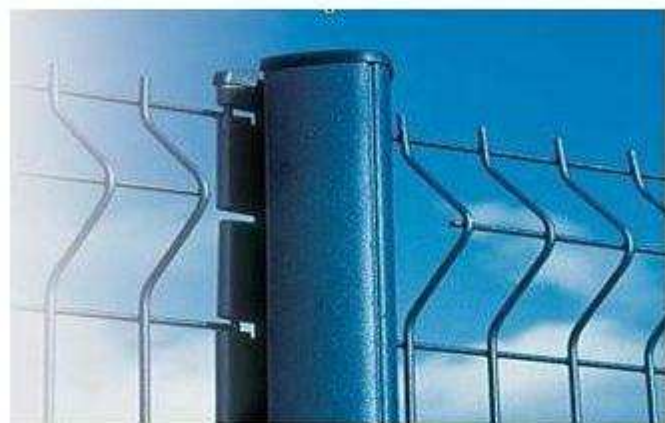

### Ograda Vitalis



#### OGRADA VITALIS

PANEL - VITALIS ŠIRINA 2450 MM, debljina horizontalne žice 4,7mm, debljina vertikalne žice, 3,9 mm, zaštita ZN + PVC, okca 200/65mm  
 STUB AXOR - 70/50 MM L= 1400,1600,2000,2200,2400mm  
 PANEL - VITALIS VISINE

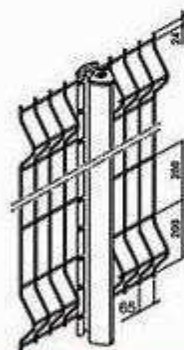
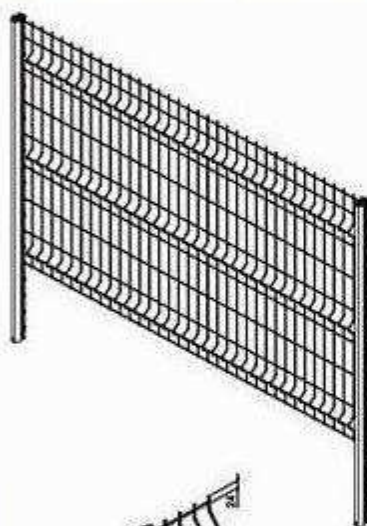
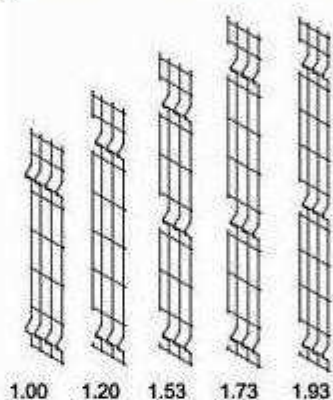

Wire diameter (mm)	Mesh (mm)	Panel width (m)	Nominal panel height (m)	Associated post and Post centres (m)
Horizontal: 4.70	200 x 65	2.450	1.00	Post AXOR ©
			1.20	
Vertical: 3.90			1.53	2.483
1.73			2.483/2.288	
1.93				





# OGRADA AXIS C

**PANEL** - AXIS-C širina panela 2480 mm , debljina horizontalne žice 6,0mm , debljina vertikalne žice, 5,0 mm + zaštita ZN + PVC  
dimenzija okca 50/200mm

**STUB** - AXIS - 100/70 mm , tip Omega profil , debljina zida 2,2 mm.Osno rastojanje je 2,536

**STUB** - AXOR - 70/50 mm , tip Omega profil , debljina zida 2,0 mm.Osno rastojanje je 2,510

Može se kombinovati sa stubom Axor ili Axis

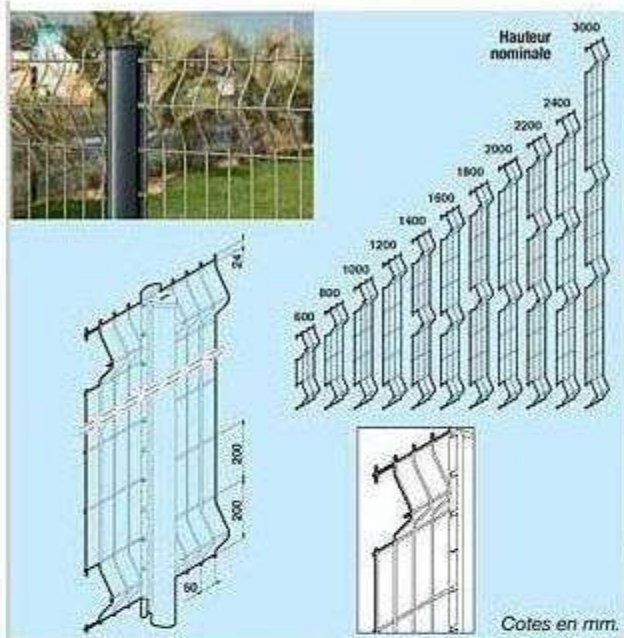

## Axis® C

En maille de 200x50 mm et avec des fils de 5 mm, AXIS® C est le panneau le plus classique de la gamme. Il répond aux attentes des clients en matière d'esthétisme et de protection.



Ø Fil (mm)	Maille (mm)	Largeur panneau (m)	Hauteur nominale panneau (m)	Poteaux associés et entraxe poteaux (m)	
Horizontal : 6  Vertical : 5	200x50	2,480	0,60	Poteau AXIS® Design (2,536 m) ou Poteau AXOR® (2,510 m)	
			0,80		
			1,00		
			1,20		
			1,40		
			1,60		
			1,80		
			2,00		
			2,20		Poteau AXIS® Design (2,536 m)
			2,40		Poteau AXIS® Design (2,371 m)
3,00					
		2,315			

Cotes en mm.





# OGRADA AXIS S

**PANEL** - AXIS-S širina panela 2480 mm, debljina horizontalne žice 4,0mm, debljina vertikalne žice, 4,0 mm + zaštita ZN + PVC  
dimenzija okca 50/100mm

**STUB** - AXIS - 100/70 mm, tip Omega profil, debljina zida 2,2 mm. Osno rastojanje je 2,536

**STUB** - AXOR- 70/50 mm, tip Omega profil, debljina zida 2,0 mm. Osno rastojanje je 2,510

Predviđeno za ugradnju sa stubom Axor

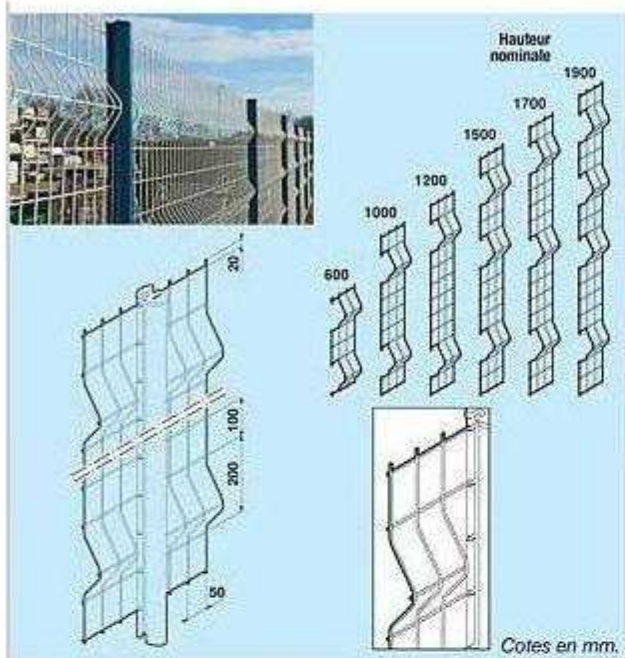

## Axis® S

L'AXIS® S est un panneau à petites mailles (100x50 mm) de diamètre 4 mm. Préconisé avec le poteau AXOR®, il bénéficie du meilleur rapport qualité/prix pour délimiter les sites peu sensibles.



Ø Fil (mm)	Maille (mm)	Largeur panneau (m)	Hauteur nominale panneau (m)	Entraxe poteau à poteau (m)	Poteau associé
Horizontal : 4	100x50	2,480	0,60	2,510	Poteau AXOR®
			1,00		
1,20					
Vertical : 4			1,50		
1,70					
1,90					

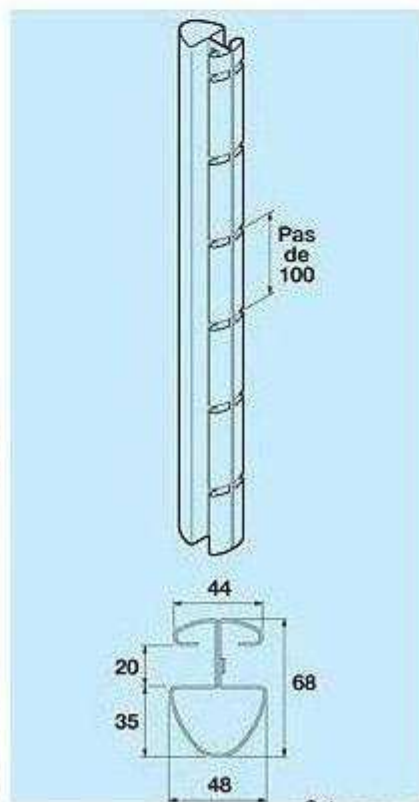



# OGRADA AXIS SR

**PANEL** - AXIS-S širina panela 2480 mm , debljina horizontalne žice 6,0mm , debljina vertikalne žice, 5,0 mm + zaštita ZN + PVC  
dimenzija okca 50/100mm

**STUB** - AXIS - 100/70 mm , tip Omega profil , debljina zida 2,2 mm.Osno rastojanje je 2,536

**STUB** - AXOR- 70/50 mm , tip Omega profil , debljina zida 2,0 mm.Osno rastojanje je 2,510

Predvidjeno za ugradnju sa stubom Axis 100/50 mm

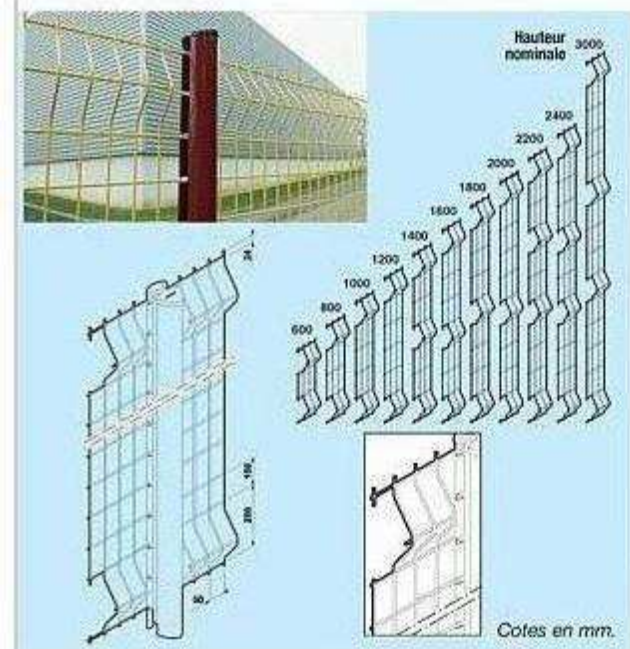

## Axis® SR

Pour une résistance proche du panneau AXIS® D, l'AXIS® SR allie rigidité (maille de 100x50 mm et diamètre de fils horizontaux de 6 mm) et raffinement des lignes (panneau à plis).  
Design unique sur le marché.



Ø Fil (mm)	Maille (mm)	Largeur panneau (m)	Hauteur nominale panneau (m)	Entraxe poteau à poteau (m)	Poteau associé
Horizontal : 6	100x50	2,480	0,60	2,536	Poteau AXIS® Design
			0,80		
			1,00		
			1,20		
			1,40		
			1,60		
			1,80		
			2,00		
			2,20		
			2,40		
Vertical : 5	100x50	2,315	3,00	2,371	



stub Axis 100/50 mm

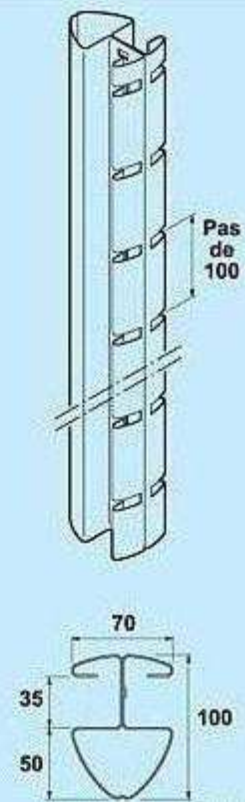



# OGRADA AXIS D i AXIS DR

**PANEL** - AXIS-D širina panela 2480 mm , debljina horizontalne žice 2 x 6,0mm , debljina vertikalne žice, 5,0 mm + zaštita ZN + PVC  
dimenzija okca 50/200mm

- AXIS -DR širina panela 2480 mm , debljina horizontalne žice 2 x 8,0mm , debljina vertikalne žice, 6,0 mm + zaštita ZN+PVC

**STUB** - AXIS - 100/70 mm , tip Omega profil , deblina zida 2,2 mm.Osno rastojanje je 2,536

Predvidjeno za ugradnju sa stubom Axis 100/50 mm

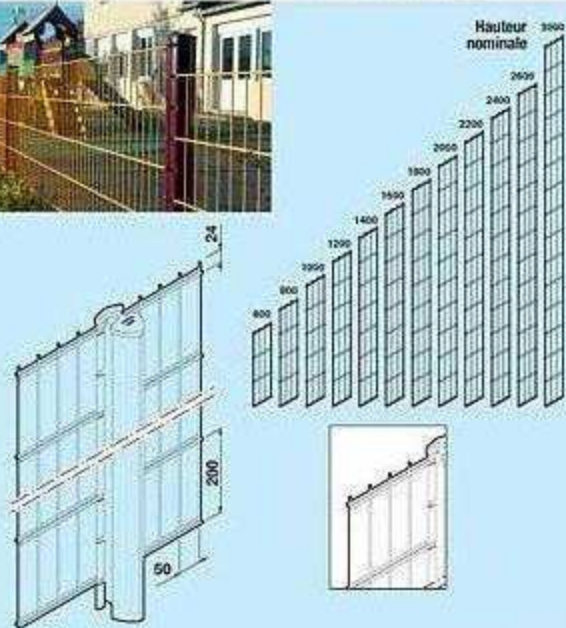

Cotes en mm.

## Axis® D

De même conception que AXIS® DR, AXIS® D protège les industries, les collectivités et administrations ainsi que les sites de sécurité. Les doubles fils horizontaux de diamètre 6 mm apportent plus de rigidité au panneau.



HAUTE SÉCURITÉ

INDUSTRIES

ADMINISTRATIONS COLLECTIVITÉS

Ø Fil (mm)	Maille (mm)	Largeur panneau (m)	Hauteur nominale panneau (m)	Entraxe poteau à poteau (m)	Poteau associé
Horizontal : 2 x 6  Vertical : 5	200x50	2,480	0,60	2,536	Poteau AXIS® Design
			0,80		
			1,00		
			1,20		
			1,40		
			1,60		
			1,80		
			2,00		
			2,20		
			2,40		
2,60	2,371				
3,00	2,315				



stub Axis 100/50 mm

